

Door Styles & Options



Inspired Living



The possibilities are endless

Can't find your dream door? We can help. At Dover Woods we have access to almost any door style you can think of. Whether it is a solid wood door or a composite material, such laminate, MDF, thermoplastic (polymer), Polyester, acrylic or other, we've got you covered. Ask your local dealer for more details.

CONTENT

5 Piece Door	4-5
1 Piece MDF Door	6
Slab Door	7
TFL Door	7
Thermo Door	8
Edge Profiles	9
Construction Joint	9
Mullion Styles	10
Glass Styles	11





INFO

Door #1: Shaker w/ construction joint
Species: Maple
Finish: Biscuit

Door #2: Nova
Species: Solid Maple
Finish: Caramel

DOOR STYLES

5 PIECE DOOR STYLES



Shaker
C-M-O-P-W-WO



Kedgwick
C-M-O-P-W-WO



Hanwell
C-M-O-P



Shaker Light
C-M-O-P-W-WO



Shaker Round
C-M-O-P-W-WO



Shaker Soft
C-M-O-P-W-WO



Shaker Chamfer
C-M-O-P-W-WO



Shaker Step
C-M-O-P-W-WO



Shaker Step Bevel
C-M-O-P-W-WO



Shaker Dome
C-M-O-P



Bar Harbour
M



Charlottetown
C-M-O-P-W-WO



Simply Shaker
C-M-O-P-W-WO



Simply Beveled
C-M-O-P-W-WO



Simply Pillow
C-M-O-P-W-WO



Simply Step
C-M-O-P-W-WO



Plymouth
C-M-O-P-W-WO



Regency
C-M-O-P



Timeless
C-M-O-P-W-WO



Portage
C-M-O-P-W-WO



Torino
C-M-O-P-W-WO



Bellmont
C-M-O-P-W-WO



Exeter Recessed
C-M-O



Classic
C-M-O-P

Available In:

C Cherry **P** Pine
M Maple **W** Walnut
O Oak **WO** White Oak Rift Cut



Also available in solid wood Reversed Raised center panel.

DOOR STYLES

5 PIECE DOOR STYLES



Classic Soft
C-M-O-P-W-WO



Royal
C-M-O-P



Dartmouth
C-M-O-P-W-WO



Natik
C-M-O-P-W-WO



Chatham Recessed
C-M-O



Duxbury Recessed
C-M-O-P



Duxbury Raised
C-M-O-P



Middletown Recessed
C-M-O-P-W-WO



Middletown Raised
C-M-O-P-W-WO



Cambridge Recessed
C-M-O-P-W-WO



Cambridge Raised
C-M-O-P-W-WO



Newport Recessed
C-M-O-P-W



Newport Raised
C-M-O-P-W



Dome
C-M-O-P



Roman
C-M-O-P



Concord
C-M-O-P



Queen Anne
C-M-O-P



Princess
C-M-O-P

80+ FINISHES TO CHOOSE FROM

At Triangle Kitchen we are known for our superior quality of finish. We offer a designer palette of paints for a smooth consistent look or stains that enhance the natural character and grain of wood. Our superior paints, stains and other finishes are applied to Maple, Oak, Cherry, Pine, Walnut and White Oak Rift Cut. From light to dark or subtle to dramatic, the options are endless.

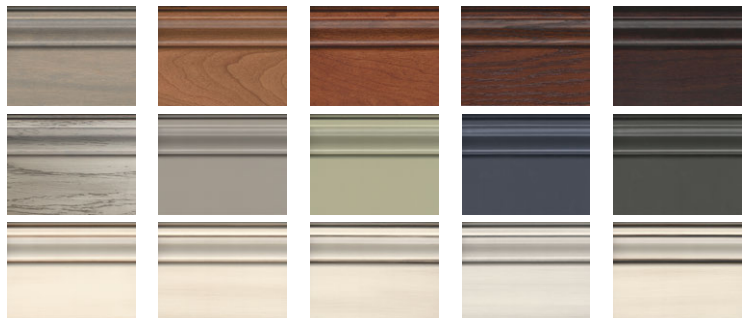

Available In:

- C** Cherry **P** Pine
- M** Maple **W** Walnut
- O** Oak **WO** White Oak Rift Cut



Also available in solid wood Reversed Raised center panel.

DOOR STYLES

1 PIECE MDF DOOR STYLES



Shaker MDF
PO

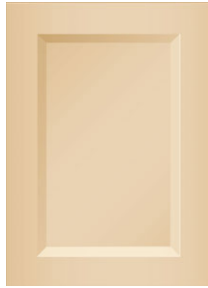

Shaker Beveled MDF
PO

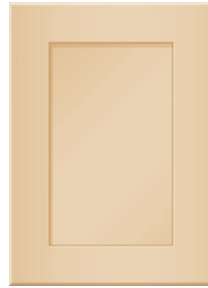

Shaker Light MDF
PO



Shaker Round MDF
PO

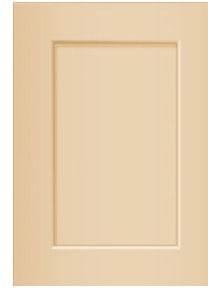

Shaker Soft MDF
PO

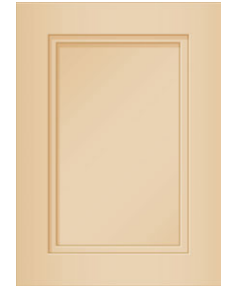

Shaker Step MDF
PO



Shaker Step Bevel MDF
PO



Simply Beveled MDF
PO

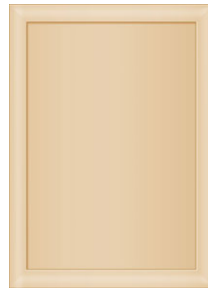

Simply Pillow MDF
PO

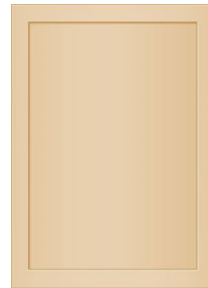

Simply Shaker MDF
PO

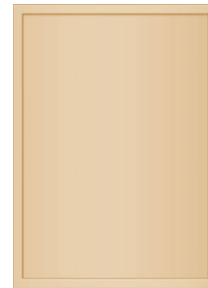

Simply Slim Shaker MDF
PO

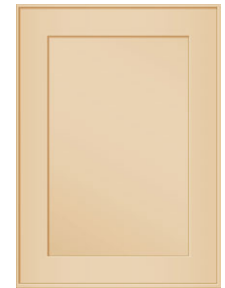

Simply Step MDF
PO

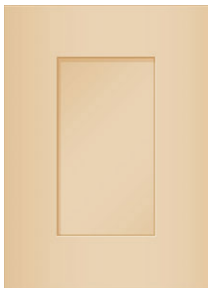

Plymouth MDF
PO



Bellmont MDF
PO

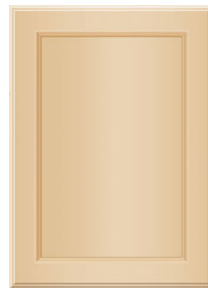

Pleasant Hill MDF
PO



Portage MDF
PO



Torino MDF
PO



Fancy Beveled MDF
PO



Queen Anne Amherst MDF
PO



Queen Anne Round MDF
PO



Roman Amherst MDF
PO



Roman Round MDF
PO



Royal Amherst MDF
PO



Royal Round MDF
PO

Available In:
PO Paint Only

DOOR STYLES

SLAB DOOR STYLES



Metro
C-M-O-P-W-WO



Nova Solid Wood
C-M-O-P-W-WO



Nova MDF
PO

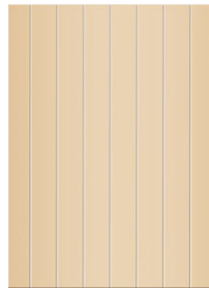

Linate MDF
PO

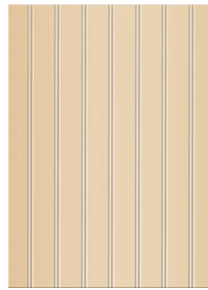

Nantucket MDF
PO

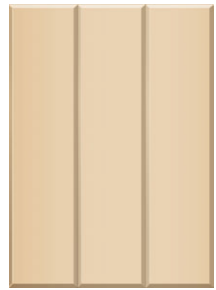

Heritage MDF
PO

TFL DOOR STYLES

Solid Colors



Urban - Ashen



White



Matt White



Folkstone



Summer Drops

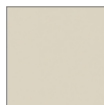

Morning Dew



Ashen



Mysterious Blue



Orion Grey

Supermatt Colors

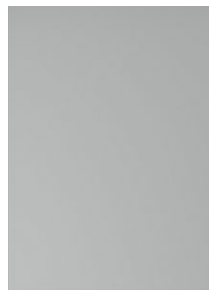

Urban - Ice Grey



Snow White



Ice Grey



Timeless Grey



Dolphin Grey



Sahara Cream

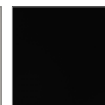

Pearl Black

Wood & Fabric



Urban - Weekend Getaway



Urban - Cast at First Light

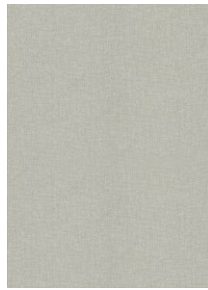

Urban - Linen



Woodgrain



Linen



Weekend Getaway

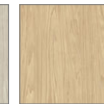

Cast at First Light



Après-Ski

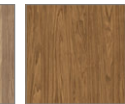

Tea for Two



Winter Fun



Sunset Cruise



Sugar on Ice



Sunday Brunch



After Hours

High Gloss Colors



Urban - Fog



Urban - Fumé



White



Artic Grey



Fog



Fumé

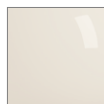

Magnolia



New Black

Many other door styles and finishes available, ask your local dealer for more details.

DOOR STYLES

THERMO DOOR STYLES



Euro



Belfast



Dublin



Nanaimo



Shaker - 5 piece



Shaker Beveled - 5 piece



Paris



Porto

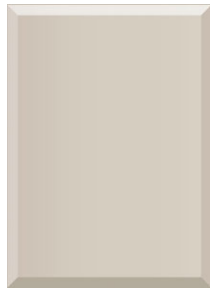

Elysa

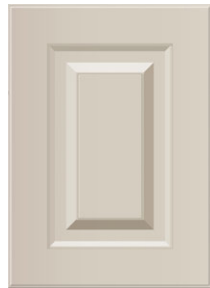

British



British Arch



British Cathedral



Scandinavian



Scandinavian Arch



Scandinavian Cathedral

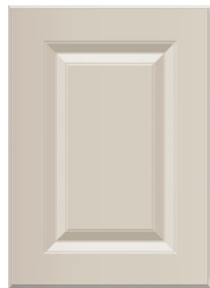

Manhattan



Manhattan Arch



Manhattan Cathedral

Thermo Colors

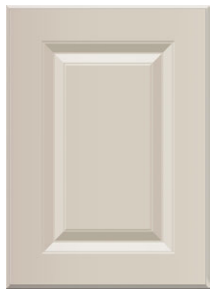

Manhattan - Morning Dew



White Deco Velvet



Cotton Mist



Summer Drops

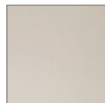

Morning Dew



Dusk



Black Velvet



Alabaster

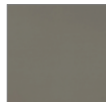

Fossil



Celadon Green



Winter Fun



Sunset Cruise

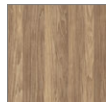

Après-Ski



Sunday Brunch

EDGE PROFILES

PROFILE #	cross sections	profile views	PROFILE #	cross sections	profile views
1			6		
2			7		
3			8		
4			10		
5			11		

! Only available on some specific doors.

! Not available for Thermo Doors.

! Not available for MDF Doors.

! Only available for Thermo Doors.

CONSTRUCTION JOINT

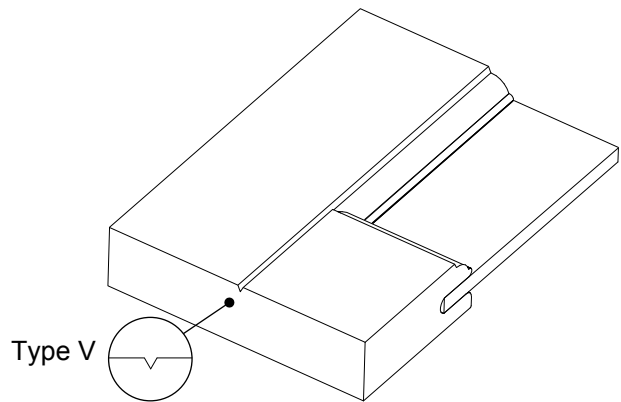
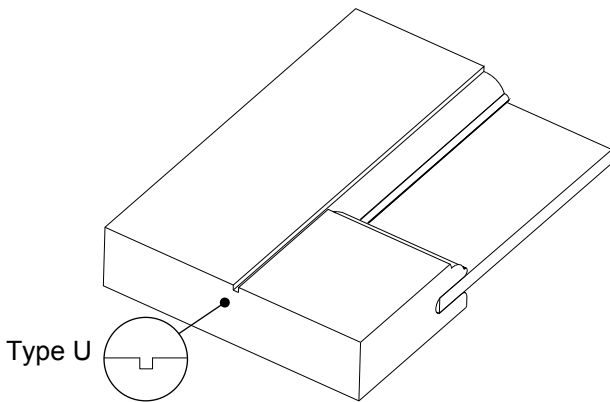

As an entirely natural material, wood is in a constant state of expansion and contraction. This is largely due to the variation of relative humidity in the house. Generally in our market, the North Eastern region of North America, the air is quite humid in the summer and dry in the winter. This last point is accentuated when heating houses in the cold dry winter months and not re-introducing humidity into the air. Because of this variation in relative humidity, hairline cracks at the joints on the finished surface of cabinet doors and frames may form. The appearance of these naturally-forming cracks will not diminish the strength of the joints, and are part of the normal settling process of finely-crafted wooden cabinetry. Doors with construction joints will conceal this issue.

! Not available on all door styles, ask your local dealer to check door specs for details.

MULLION STYLES

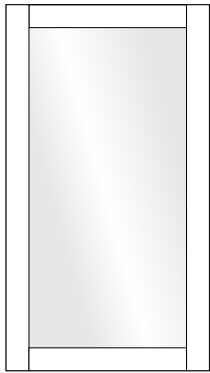

Frame Only

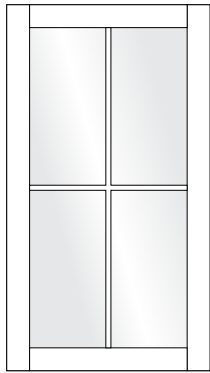

4 Lites

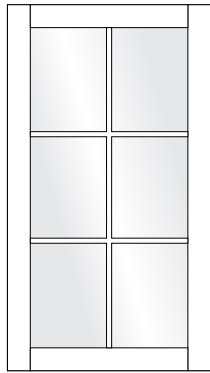

6 Lites

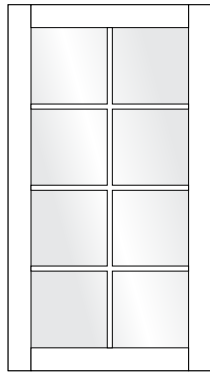

8 Lites

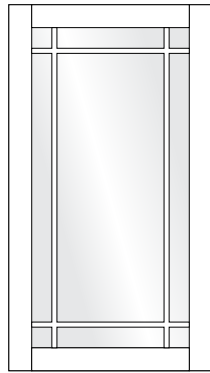

Deluxe Mullion

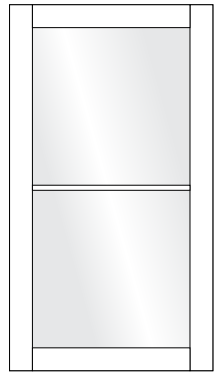

2 Lites Horizontal

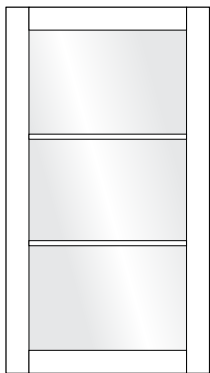

3 Lites Horizontal

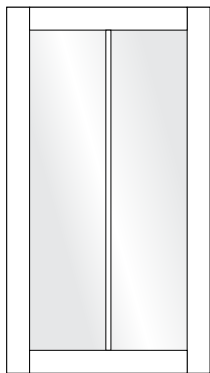

2 Lites Vertical

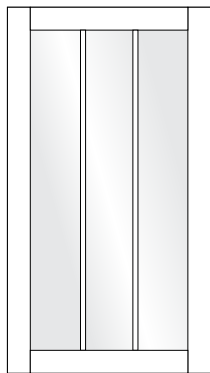

3 Lites Vertical

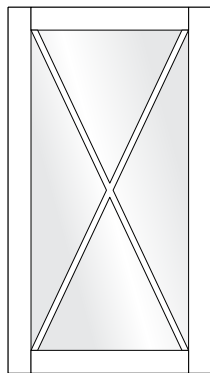

X-Mullion

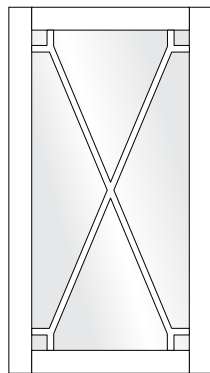

Deluxe X-Mullion

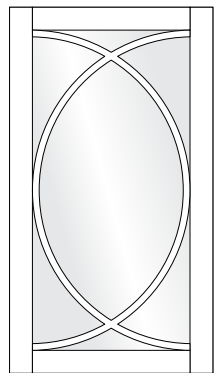

Fancy Mullion

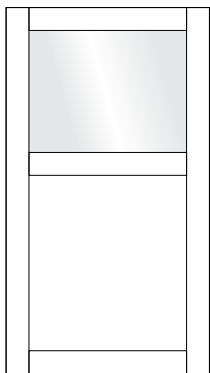

Special Frame Only

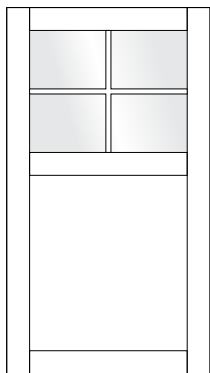

Special Mullion
4 Lites

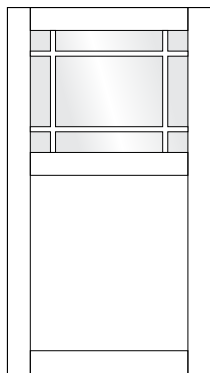

Special Mullion
Deluxe

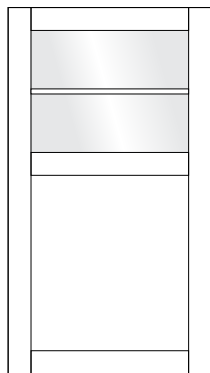

Special Mullion
2 Lites Horizontal

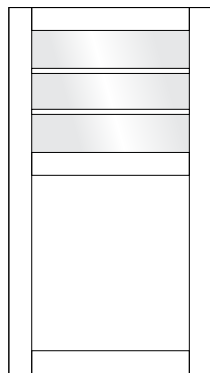

Special Mullion
3 Lites Horizontal

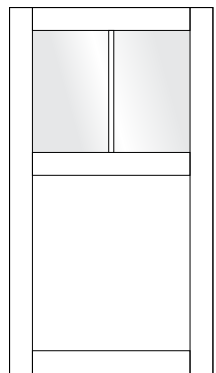

Special Mullion
2 Lites Vertical

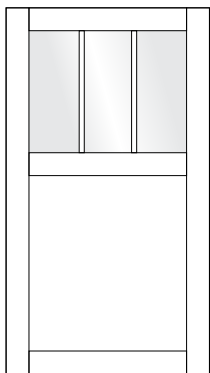

Special Mullion
3 Lites Vertical

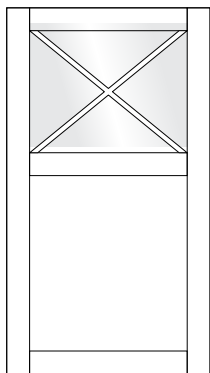

Special X-Mullion

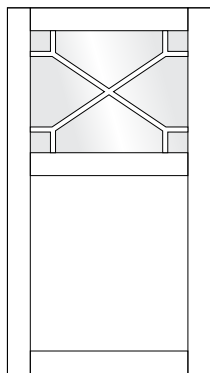

Special Deluxe X-Mullion

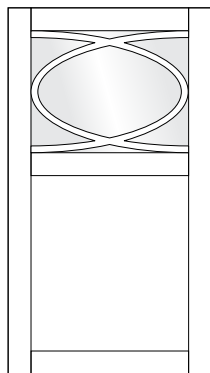

Special Fancy Mullion

GLASS STYLES

Glass Style Options

Glass Doors are available in various styles, allowing you to transform any door in your project into a showpiece. These doors can be equipped with various Mullion Types.

See your local dealer for more information on our Glass Doors.



Clear



Mirror



Smoked



Delta



Frosted



Reeded



Gothic



INFO

Doors: Shaker w/ construction joint
Species: Maple & MDF
Finish: Winter White



INFO

Doors: Shaker w/ construction joint
 Species: Maple & MDF
 Finish: Winter White



THE DOVER WOODS DIFFERENCE

Choosing Dover Woods isn't about just selecting a door style or wood species. It's about designing a kitchen that works as hard as you do, with distinctive touches that complement your individual style. With quality guaranteed, you can let your imagination run wild and create the kitchen you've always dreamed of. Whether you want to dazzle your guests with sleek contemporary designs or timeless classics Triangle offers virtually unlimited choices to complement the architecture of a home and a homeowner's sense of style.

The Dover Woods Difference is our hands-on craftsmanship. We produce 95% of our own doors, allowing us to carefully select the best materials available in order to deliver the highest quality product. All of this is backed by our superior warranty*.

***For warranty details please visit our website www.doverwoods.com**



679 Babin St., Dieppe, NB, E1A 5M7 Canada
 Toll Free: 1-800-563-5482 • Tel: (506) 858-5855 • www.doverwoods.com

COVER INFO: Doors: Urban / Species: TFL / Finish: High Gloss White

Note: Actual appearance of products presented in this brochure may vary due to commercial printing limitations, variations in lighting and the natural aging properties of woods and finishes. In order to view true door & finish samples, please visit your authorized dealer.